

## AGRICULTURA

### SEMILLERO S84

► **DIMENSIONES EXT**

526 x 333 x 60 mm

► **VOLUMEN ALVEOLO**

46,87 cm<sup>3</sup>

► **Nº ALVEOLOS**

84

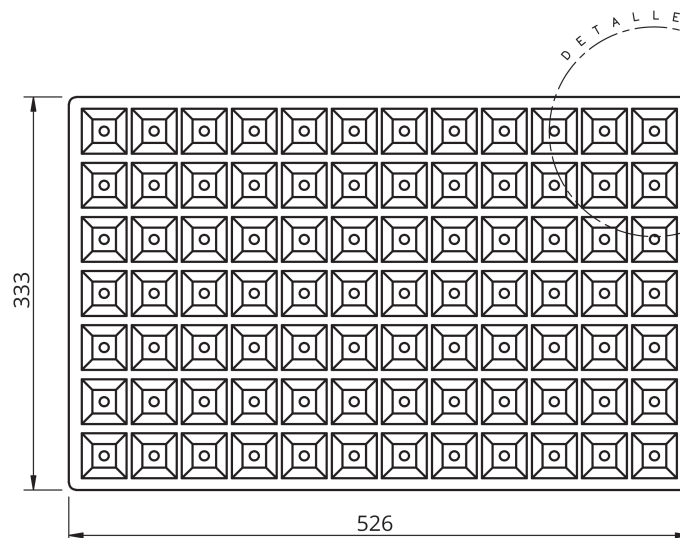

PLANTA SUPERIOR

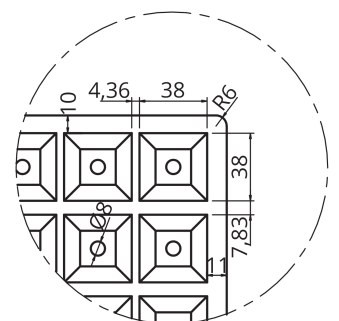

DETALLE A