



PESCADOS Y MARISCOS

ENVASE MERCA3

► **DIMENSIONES EXT**

400 x 400 x 123 mm

► **DIMENSIONES INT**

347 x 347 x 95 mm

► **CAPACIDAD**

11,44 L

► **TAPA**

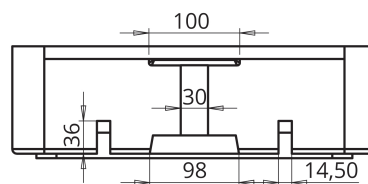

ALZADO FRONTAL

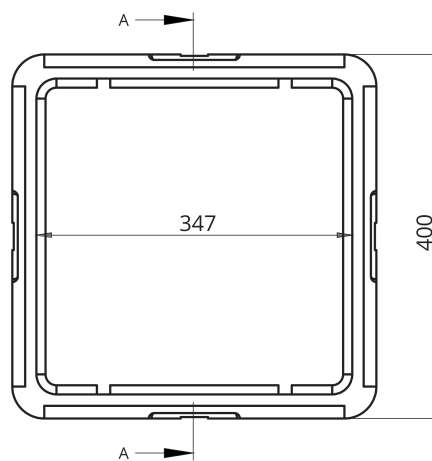

PLANTA SUPERIOR

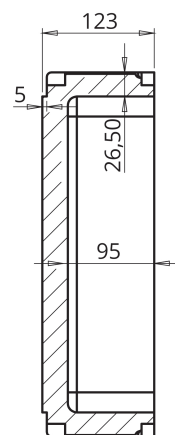

SECCION A-A