



PESCADOS Y MARISCOS

ENVASE MH1

► **DIMENSIONES EXT**

367 x 273 x 55 mm

► **DIMENSIONES INT**

347 x 253 x 45 mm

► **CAPACIDAD**

3,6 L

► **TAPA**

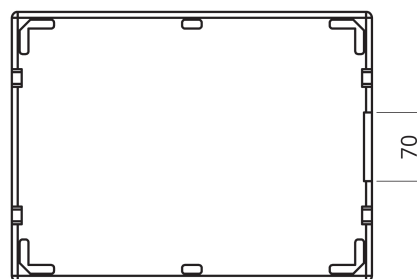

PLANTA INFERIOR

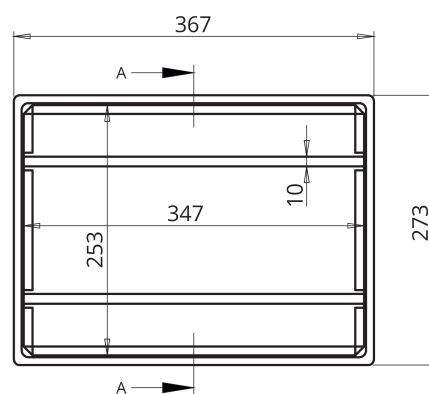

PLANTA SUPERIOR

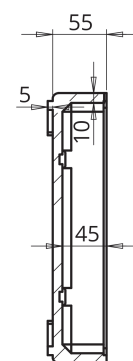

SECCION A-A